



3rd FAI World Aerobatic Yak-52 Championships 2012

June 23 - 30, 2012

FORM B

Pilot ID #

Yak-52 Free

Flight #

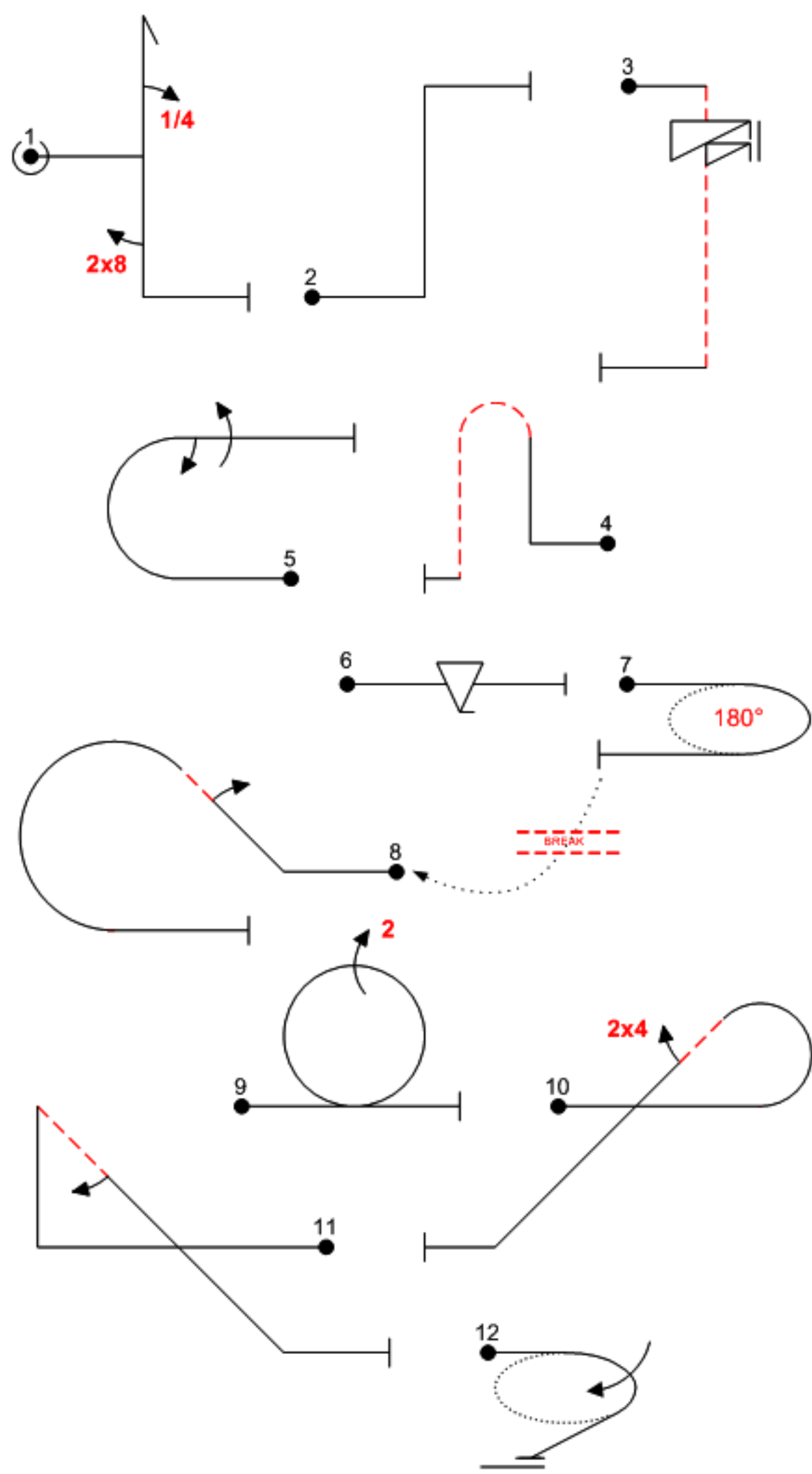
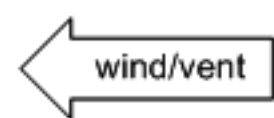

Fig 1	5.2.1.1 9.1.1.1 9.8.5.1	17 6 3	26
Fig 2	1.1.6.1	10	10
Fig 3	1.1.6.3 9.11.1.6	10 3	13
Fig 4	8.4.3.1	15	15
Fig 5	7.2.2.1 9.1.3.2 9.1.3.4	6 4 8	18
Fig 6	1.1.1.1 9.9.3.4	2 11	13
Fig 7	2.2.1.1	4	4
Fig 8	8.5.2.1 9.1.2.2	10 6	16
Fig 9	7.4.1.1 9.2.3.4	10 9	19
Fig 10	8.5.6.1 9.4.4.2	10 5	15
Fig 11	1.2.7.1 9.1.4.2	13 4	17
Fig 12	2.1.3.1	14	14
Total K = 180			

Pashchuk, Belarus
Yak-52
pilof
A/C



3rd FAI World Aerobatic Yak-52 Championships 2012

June 23 - 30, 2012

FORM B

Pilot ID #

Yak-52 Free

Flight #

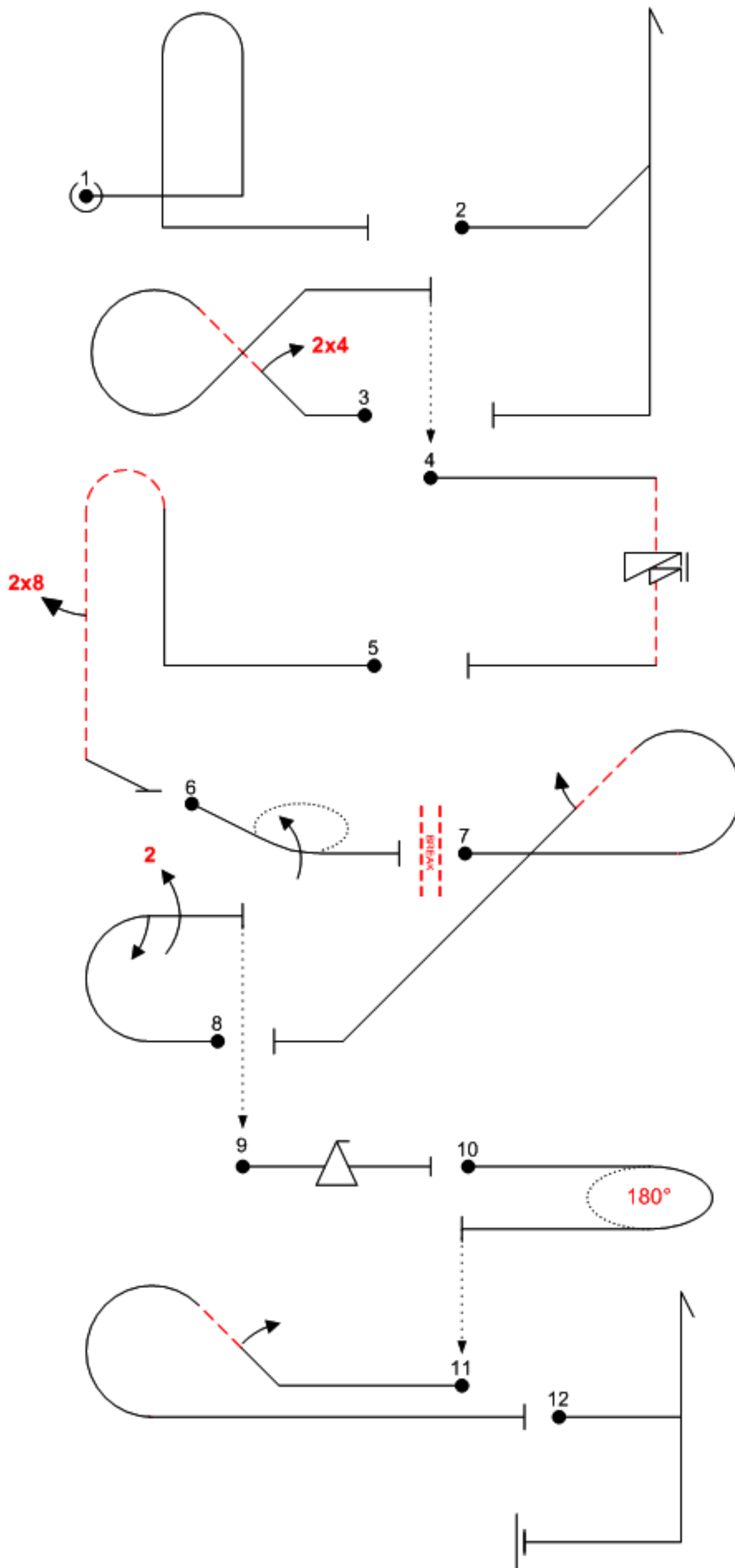

Fig 1	8.4.1.1	13	13
Fig 2	5.3.1.1	18	18
Fig 3	7.3.2.1 9.4.2.2	14 7	21
Fig 4	1.1.6.3 9.11.1.6	10 3	13
Fig 5	8.4.3.1 9.8.5.1	15 3	18
Fig 6	2.1.3.1	14	14
Fig 7	8.5.6.1 9.1.4.2	10 4	14
Fig 8	7.2.2.1 9.2.3.4 9.1.3.2	6 9 4	19
Fig 9	1.1.1.1 9.9.3.4	2 11	13
Fig 10	2.2.1.1	4	4
Fig 11	8.5.2.1 9.1.2.2	10 6	16
Fig 12	5.2.1.1	17	17

Total K = 180

Shamardin, Belarus pilot
Yak-52 A/C



Pilot ID #	Yak-52 Free	Flight #
------------	--------------------	----------

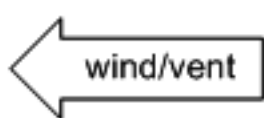
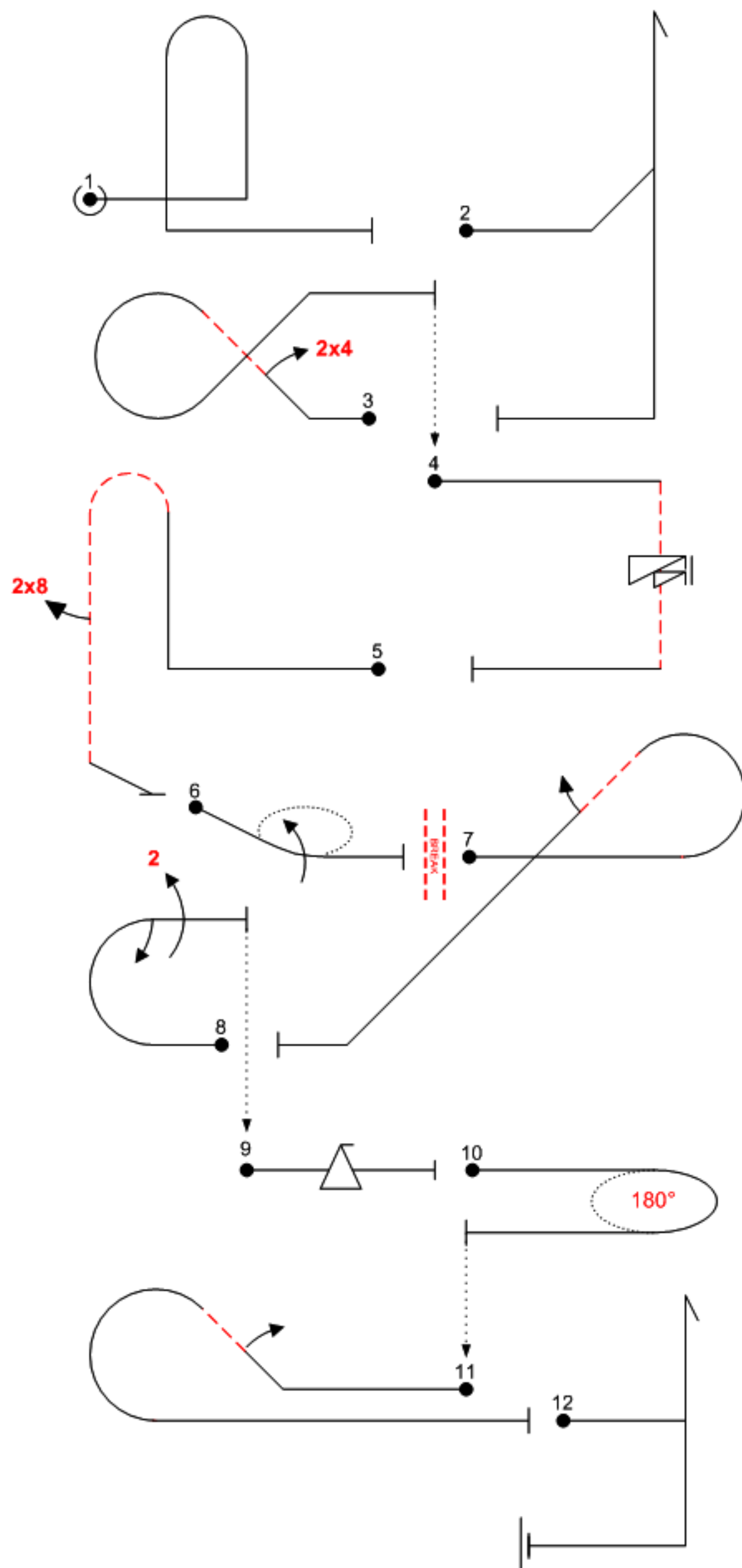

Fig 1	8.4.1.1	13	13
Fig 2	5.3.1.1	18	18
Fig 3	7.3.2.1 9.4.2.2	14 7	21
Fig 4	1.1.6.3 9.11.1.6	10 3	13
Fig 5	8.4.3.1 9.8.5.1	15 3	18
Fig 6	2.1.3.1	14	14
Fig 7	8.5.6.1 9.1.4.2	10 4	14
Fig 8	7.2.2.1 9.2.3.4 9.1.3.2	6 9 4	19
Fig 9	1.1.1.1 9.9.3.4	2 11	13
Fig 10	2.2.1.1	4	4
Fig 11	8.5.2.1 9.1.2.2	10 6	16
Fig 12	5.2.1.1	17	17
Total K = 180			

Shkarenda Belarus pilot
Yak-52 A/C



Pilot ID #

Yak-52 Free

Flight #

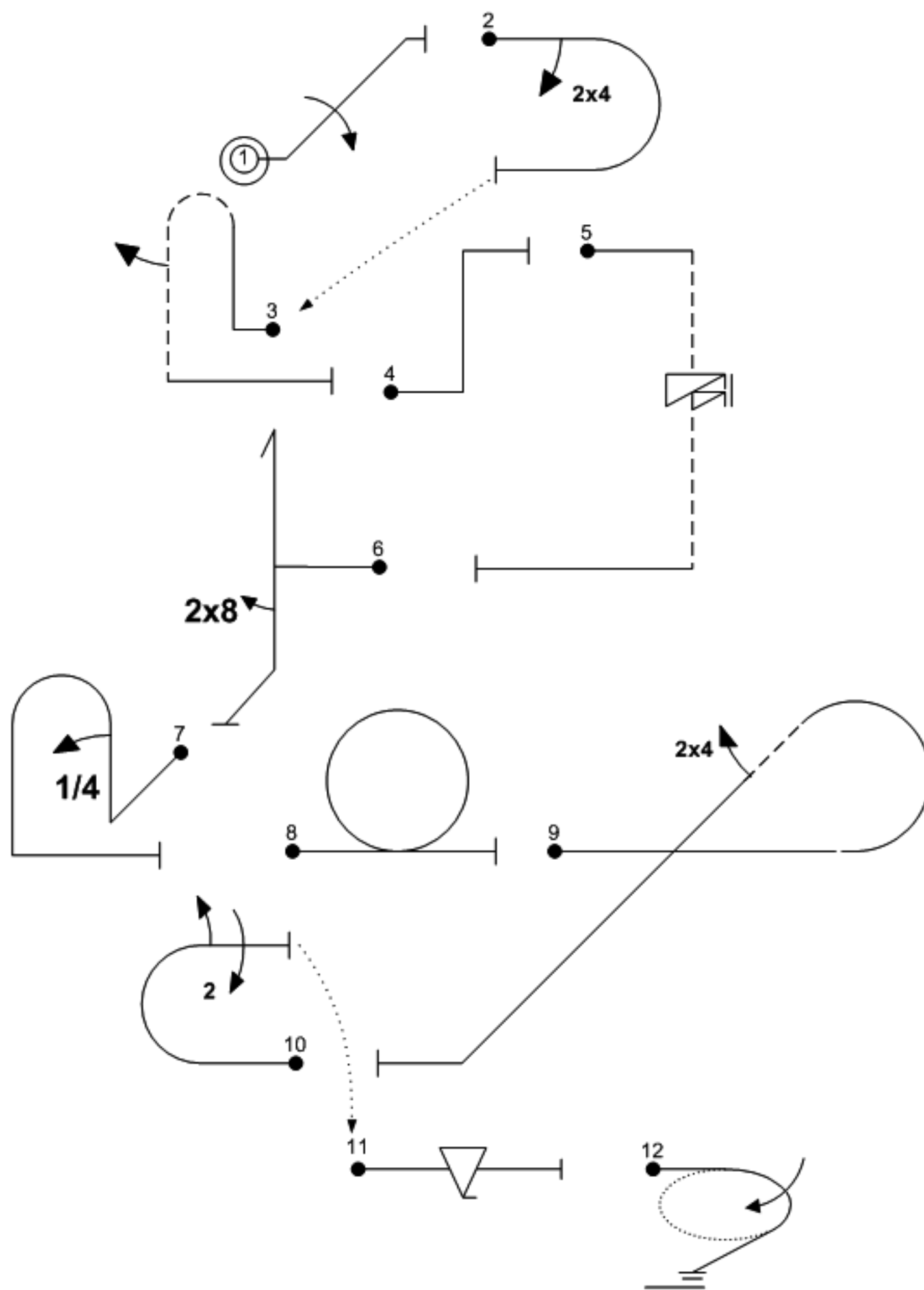
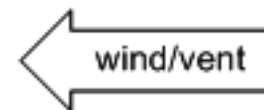

Fig 1	1.1.2.1 9.1.2.4	7 10	17
Fig 2	7.2.3.3 9.4.3.2	6 5	11
Fig 3	9.1.5.2 8.4.3.1	4 15	19
Fig 4	1.1.6.1	10	10
Fig 5	1.1.6.3 9.11.1.6	10 3	13
Fig 6	5.2.1.1 9.8.5.1	17 3	20
Fig 7	9.1.1.1 8.4.1.1	6 13	19
Fig 8	7.4.1.1	10	10
Fig 9	8.5.6.1 9.4.4.2	10 5	15
Fig 10	7.2.2.1 9.1.3.2 9.2.3.4	6 4 9	19
Fig 11	1.1.1.1 9.9.3.4	2 11	13
Fig 12	2.1.3.1	14	14
Total K = 180			

Безденежных, Мякишев,
Котельников, Голубцов, Россия
Yak-52 pilot
A/C



3rd FAI World Aerobatic Yak-52 Championships 2012

June 23 - 30, 2012

FORM B

Pilot ID #

Yak-52 Free

Flight #

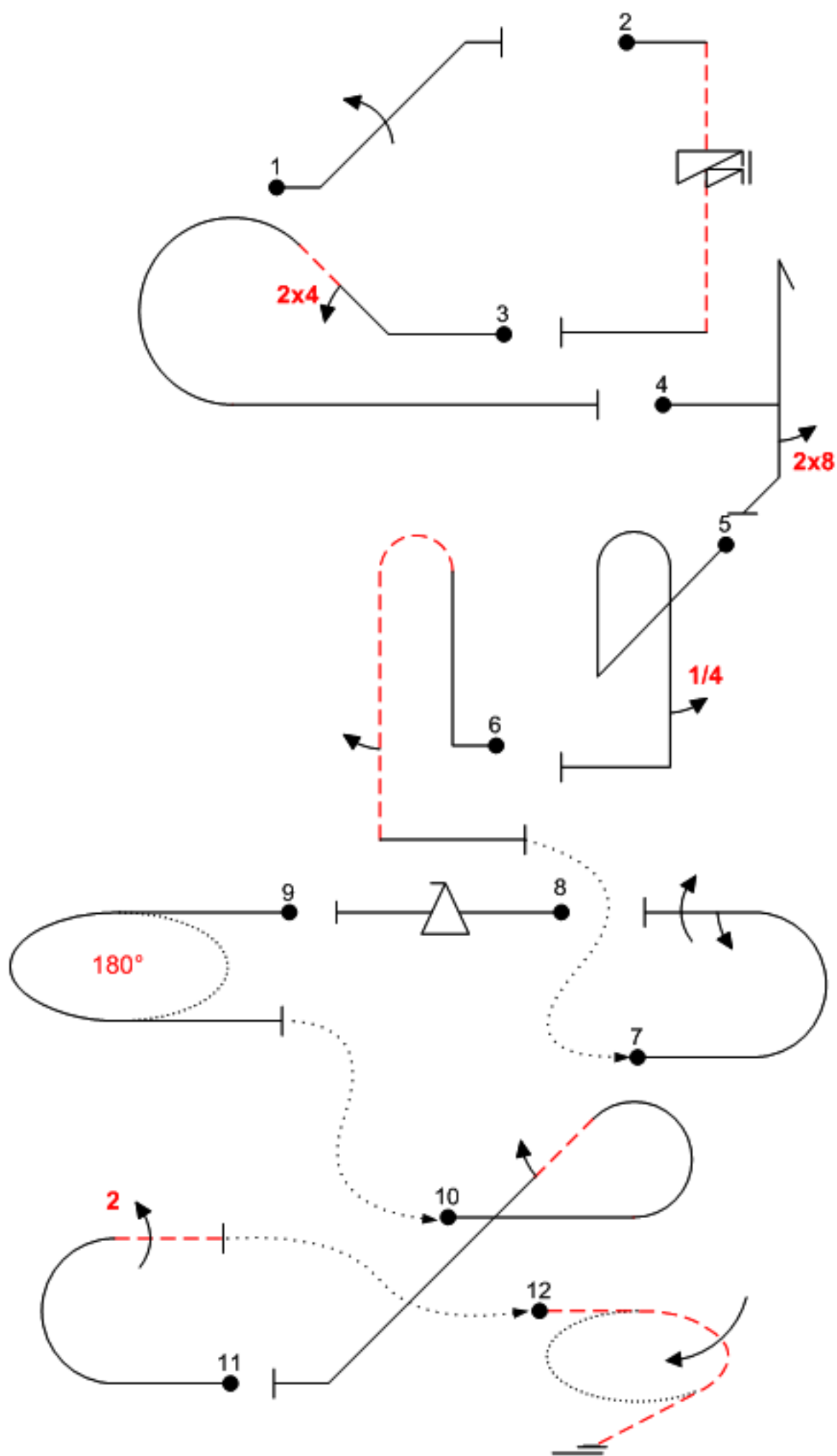
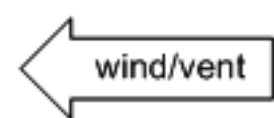

Fig 1	1.1.2.1 9.1.2.4	7 10	17
Fig 2	1.1.6.3 9.11.1.6	10 3	13
Fig 3	8.5.2.1 9.4.2.2	10 7	17
Fig 4	5.2.1.1 9.8.5.1	17 3	20
Fig 5	8.4.1.1 9.1.5.1	13 2	15
Fig 6	8.4.3.1 9.1.5.2	15 4	19
Fig 7	7.2.2.1 9.1.3.2 9.1.3.4	6 4 8	18
Fig 8	1.1.1.1 9.9.3.4	2 11	13
Fig 9	2.2.1.1	4	4
Fig 10	8.5.6.1 9.1.4.2	10 4	14
Fig 11	7.2.1.1 9.2.3.4	6 9	15
Fig 12	2.1.3.2	15	15
Total K = 180			

Bezaras, Lithuania
Yak-52
pilots
A/C

Pilot ID #

Yak-52 Free

Flight #

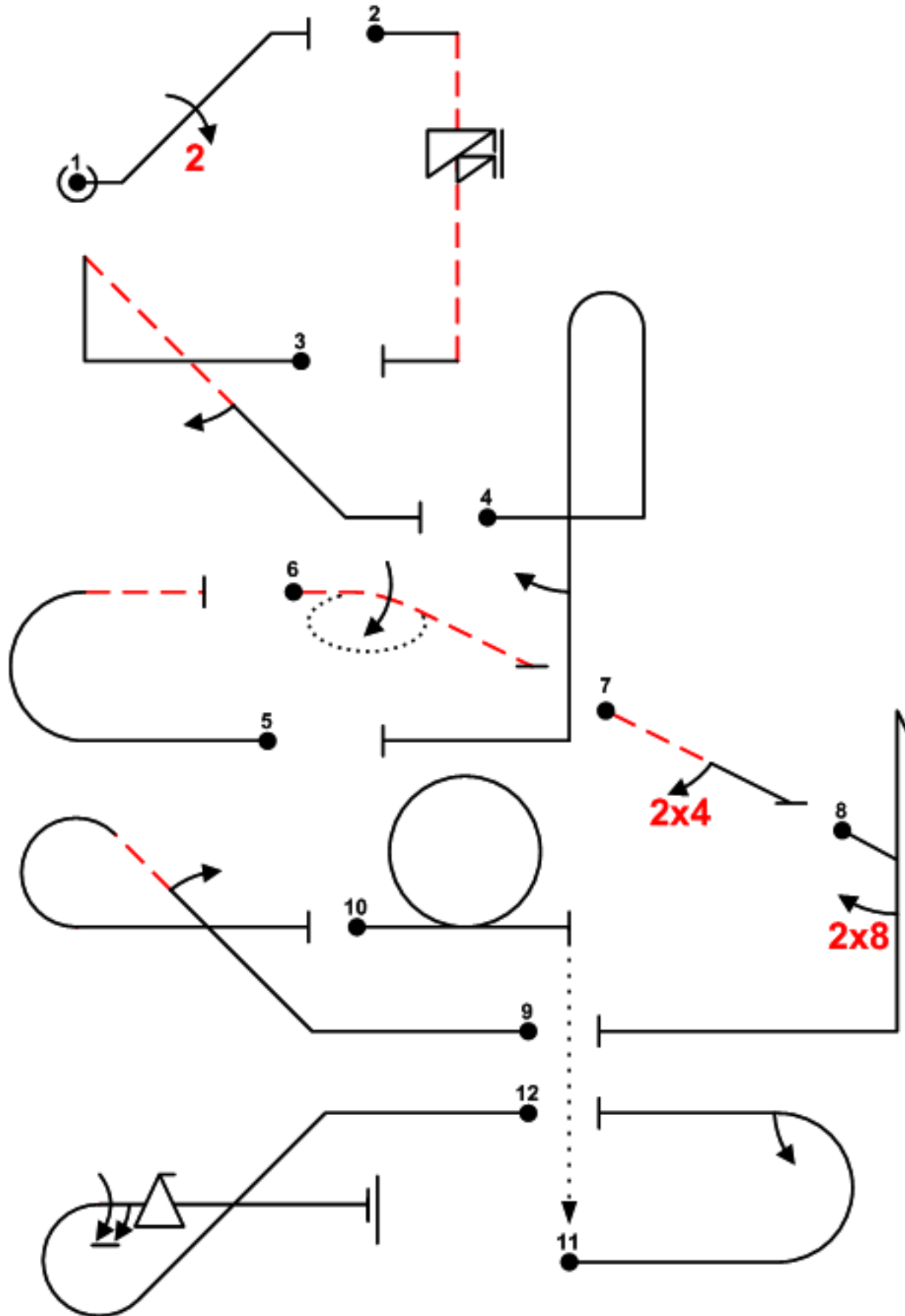

Fig 1	1.1.2.1 9.2.2.4	7 11	18
Fig 2	1.1.6.3 9.11.1.6	10 3	13
Fig 3	1.2.7.1 9.1.4.2	13 4	17
Fig 4	8.4.1.1 9.1.5.2	13 4	17
Fig 5	7.2.1.1	6	6
Fig 6	2.1.3.2	15	15
Fig 7	1.1.1.4 9.4.3.2	2 5	7
Fig 8	5.2.1.1 9.8.5.1	17 3	20
Fig 9	8.5.2.1 9.1.2.2	10 6	16
Fig 10	7.4.1.1	10	10
Fig 11	7.2.2.1 9.1.3.2	6 4	10
Fig 12	8.5.3.3 9.1.3.6 9.9.3.4	10 10 11	31
Total K = 180			



3rd FAI World Aerobatic Yak-52 Championships 2012

June 23 - 30, 2012

FORM B

Pilot ID #	Yak-52 Free	Flight #
------------	-------------	----------

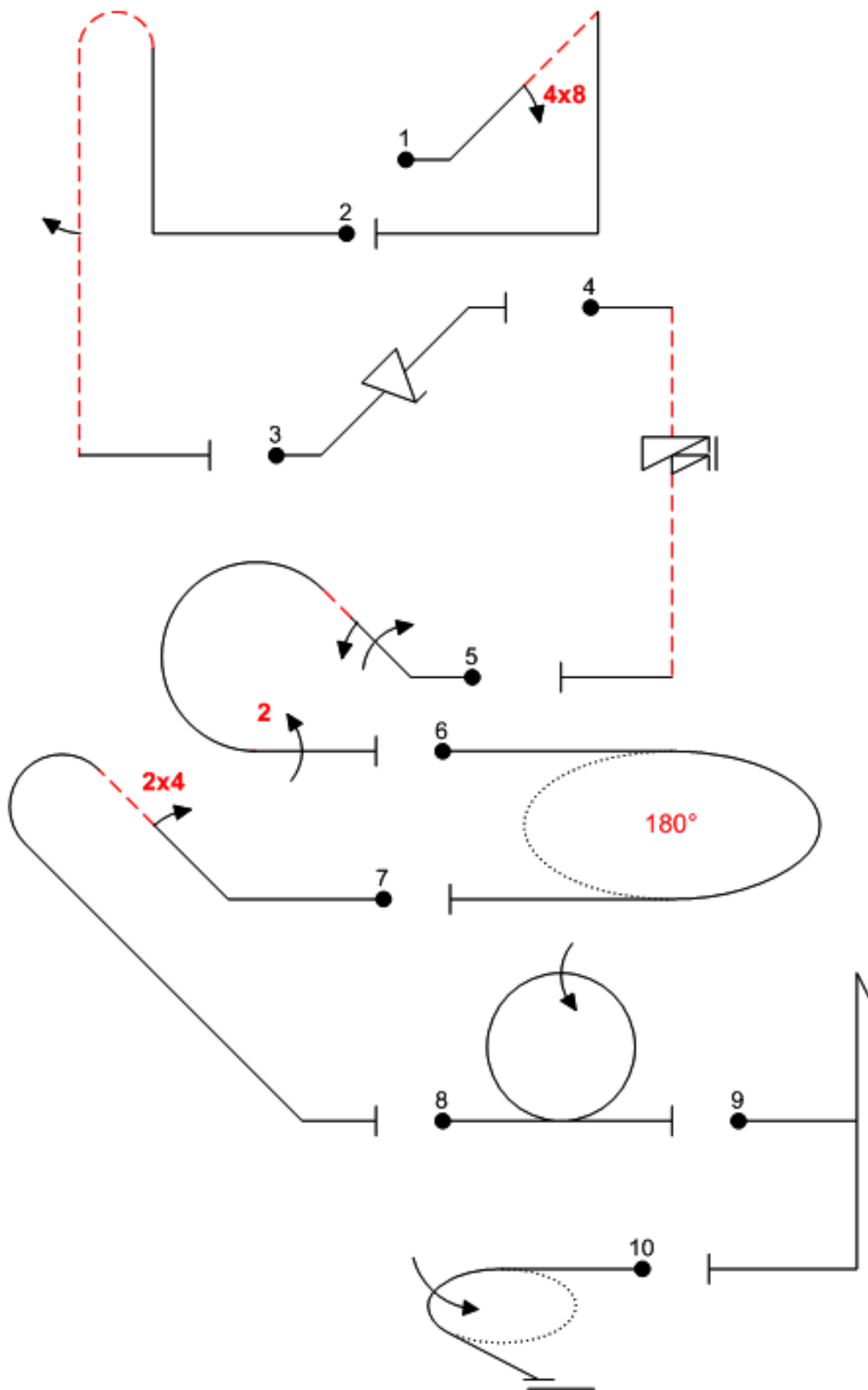
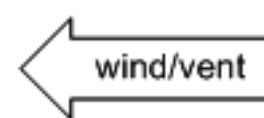

Fig 1	1.2.3.1 9.8.2.2	12 9	21
Fig 2	8.4.3.1 9.1.5.2	15 4	19
Fig 3	1.1.2.1 9.9.2.4	7 13	20
Fig 4	1.1.6.3 9.11.1.6	10 3	13
Fig 5	8.5.2.1 9.1.2.4 9.1.2.2 9.2.3.4	10 10 6 9	35
Fig 6	2.2.1.1	4	4
Fig 7	8.4.15.1 9.4.2.2	12 7	19
Fig 8	7.4.1.1 9.1.3.4	10 8	18
Fig 9	5.2.1.1	17	17
Fig 10	2.1.3.1	14	14
Total K = 180			

Davydkin, Ukraine
Yak-52
pilof
A/C

Pilot ID #

Yak-52 Free

Flight #

wind/vent

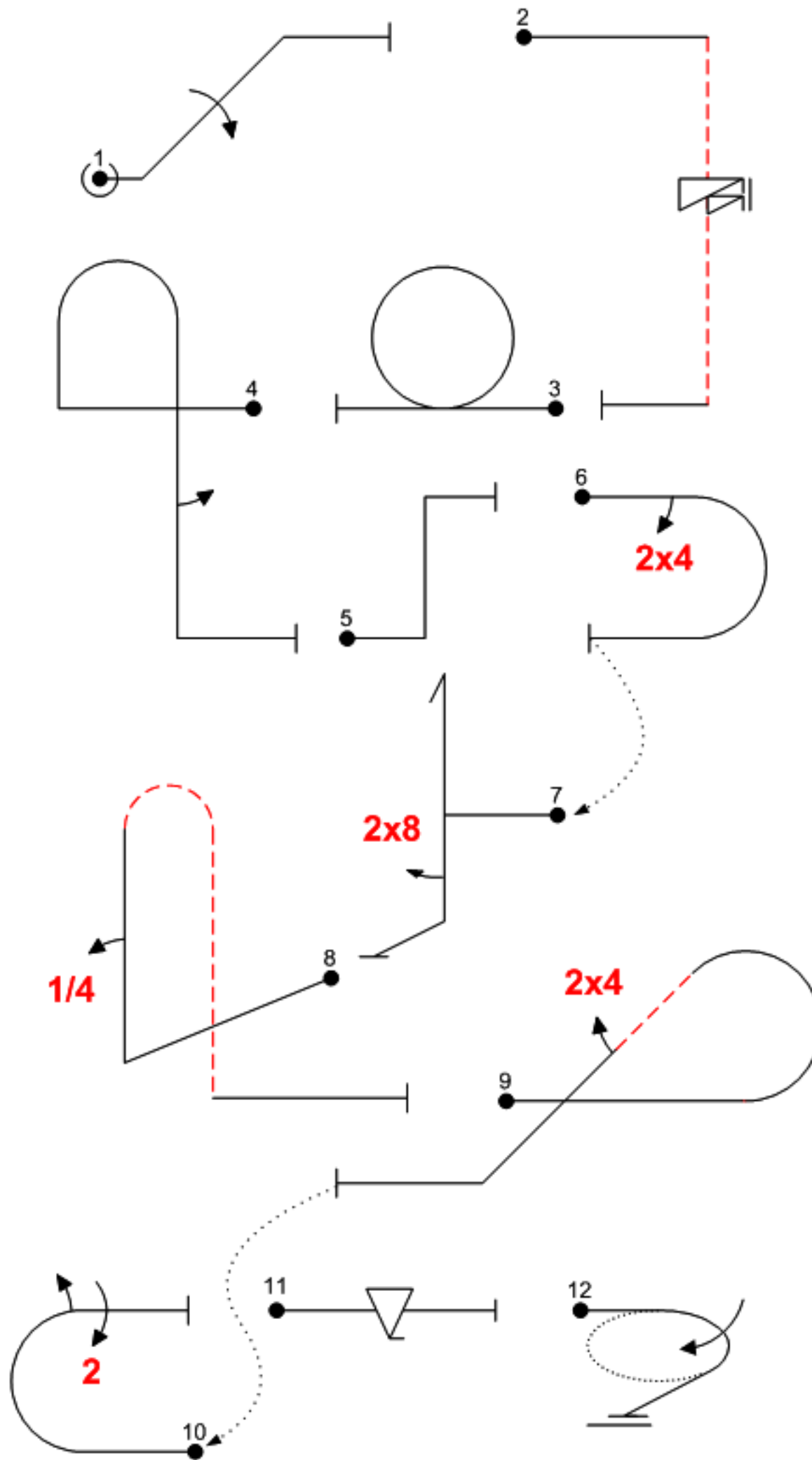

Fig 1	1.1.2.1 9.1.2.4	7 10	17
Fig 2	1.1.6.3 9.11.1.6	10 3	13
Fig 3	7.4.1.1	10	10
Fig 4	8.4.1.1 9.1.5.2	13 4	17
Fig 5	1.1.6.1	10	10
Fig 6	7.2.3.3 9.4.3.2	6 5	11
Fig 7	5.2.1.1 9.8.5.1	17 3	20
Fig 8	8.4.3.1 9.1.1.1	15 6	21
Fig 9	8.5.8.1 9.4.4.2	10 5	15
Fig 10	7.2.2.1 9.1.3.2 9.2.3.4	6 4 9	19
Fig 11	1.1.1.1 9.9.3.4	2 11	13
Fig 12	2.1.3.1	14	14
Total K = 180			

Дадькин, Плотников, Антонова,
Россия
Yak-52
пилот
А/С



Pilot ID #

Yak-52 Free

Flight #

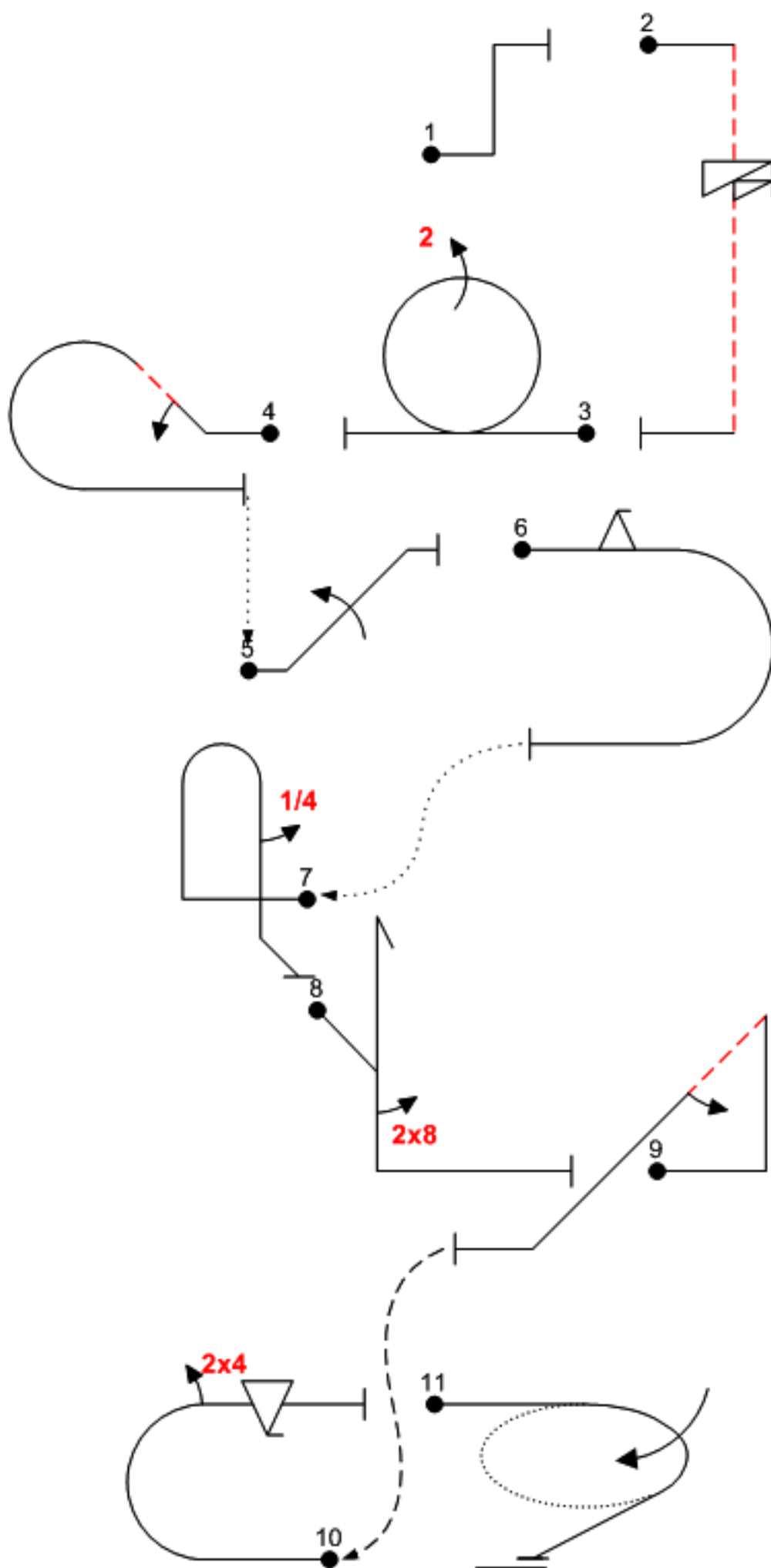
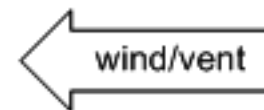

Fig 1	1.1.6.1	10	10
Fig 2	1.1.6.3 9.11.1.6	10 3	13
Fig 3	7.4.1.1 9.2.3.4	10 9	19
Fig 4	8.5.2.1 9.1.2.2	10 6	16
Fig 5	1.1.2.1 9.1.2.4	7 10	17
Fig 6	7.2.3.3 9.9.3.2	6 11	17
Fig 7	8.4.1.1 9.1.5.1	13 2	15
Fig 8	5.2.1.1 9.8.5.1	17 3	20
Fig 9	1.2.7.1 9.1.4.2	13 4	17
Fig 10	7.2.2.1 9.9.3.4 9.4.3.2	6 11 5	22
Fig 11	2.1.3.1	14	14
Total K = 180			

Kachanauskas, Lithuania pilot
Yak-52 A/C



3rd FAI World Aerobatic Yak-52
Championships 2012

June 23 -
30, 2012

FORM B

Pilot ID #

Yak-52 Free

Flight #

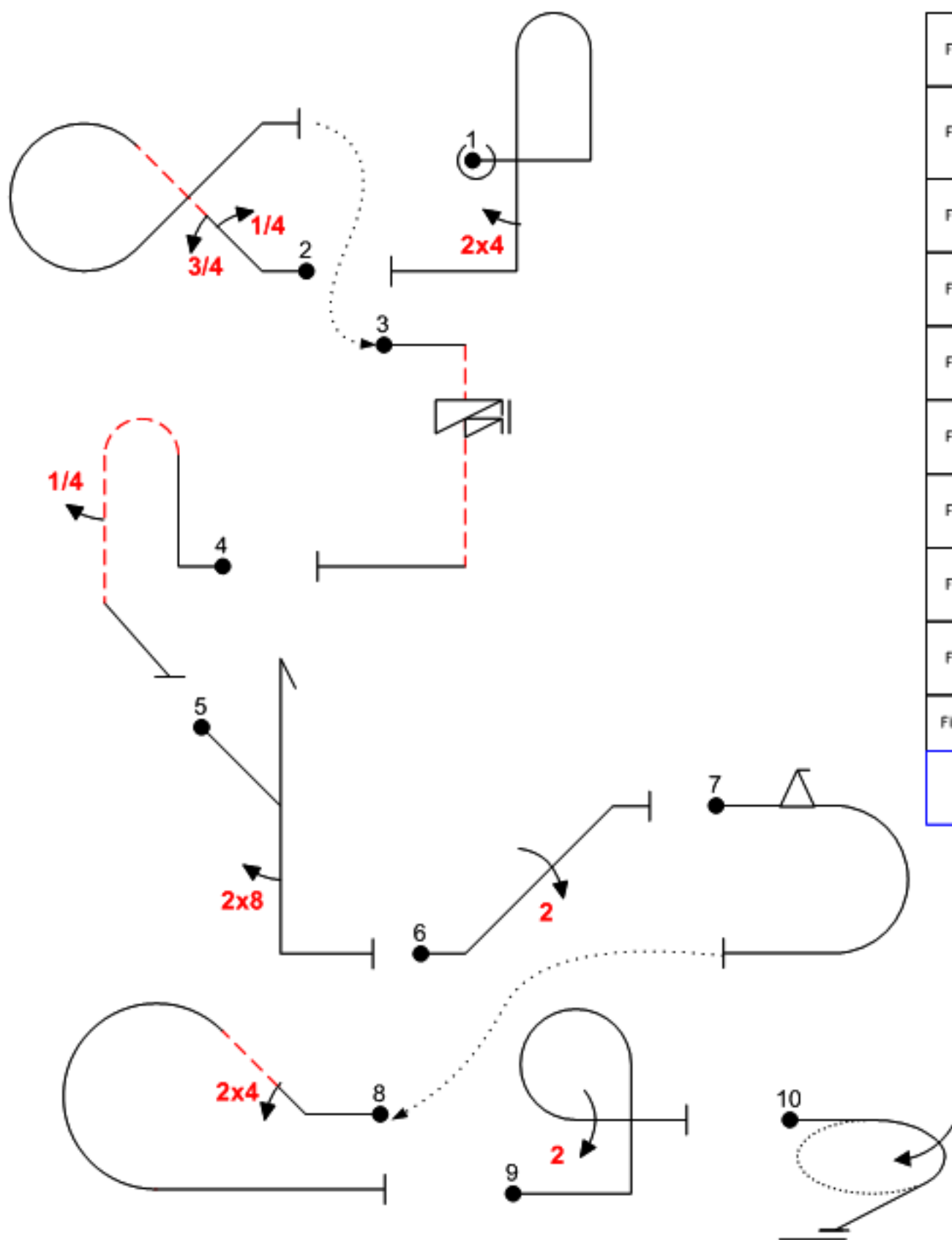
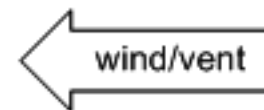

Fig 1	8.4.1.1 9.4.5.2	13 5	18
Fig 2	7.3.2.1 9.1.2.1 9.1.2.3	14 4 8	26
Fig 3	1.1.6.3 9.11.1.6	10 3	13
Fig 4	8.4.3.1 9.1.5.1	15 2	17
Fig 5	5.2.1.1 9.8.5.1	17 3	20
Fig 6	1.1.2.1 9.2.2.4	7 11	18
Fig 7	7.2.3.3 9.9.3.2	6 11	17
Fig 8	8.5.2.1 9.4.2.2	10 7	17
Fig 9	8.6.1.1 9.2.3.4	11 9	20
Fig 10	2.1.3.1	14	14
Total K = 180			

Летучев, Россия
Yak-52
пилот
A/C



Pilot ID #

Yak-52 Free

Flight #

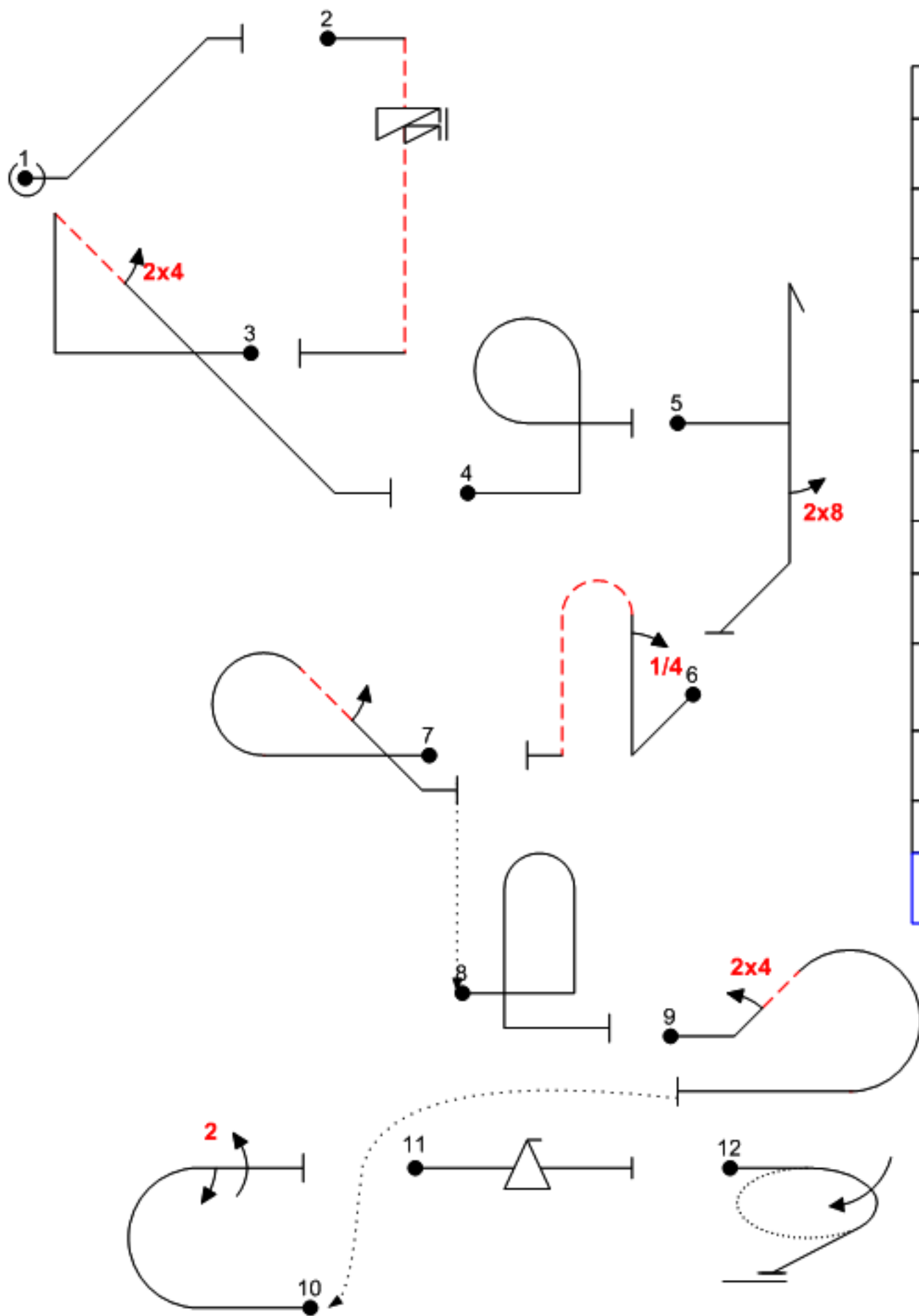
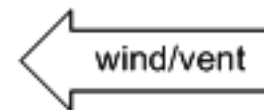

Fig 1	1.1.2.1	7	7
Fig 2	1.1.6.3 9.11.1.6	10 3	13
Fig 3	1.2.7.1 9.4.4.2	13 5	18
Fig 4	8.6.1.1	11	11
Fig 5	5.2.1.1 9.8.5.1	17 3	20
Fig 6	8.4.3.1 9.1.1.1	15 6	21
Fig 7	8.5.6.1 9.1.4.2	10 4	14
Fig 8	8.4.1.1	13	13
Fig 9	8.5.2.1 9.4.2.2	10 7	17
Fig 10	7.2.2.1 9.1.3.2 9.2.3.4	6 4 9	19
Fig 11	1.1.1.1 9.9.3.4	2 11	13
Fig 12	2.1.3.1	14	14
Total K = 180			

Овчинников, Россия, Стоянов,
Bulgaria
Yak-52 pilot
A/C



Pilot ID #	Yak-52 Free	Flight #
------------	-------------	----------

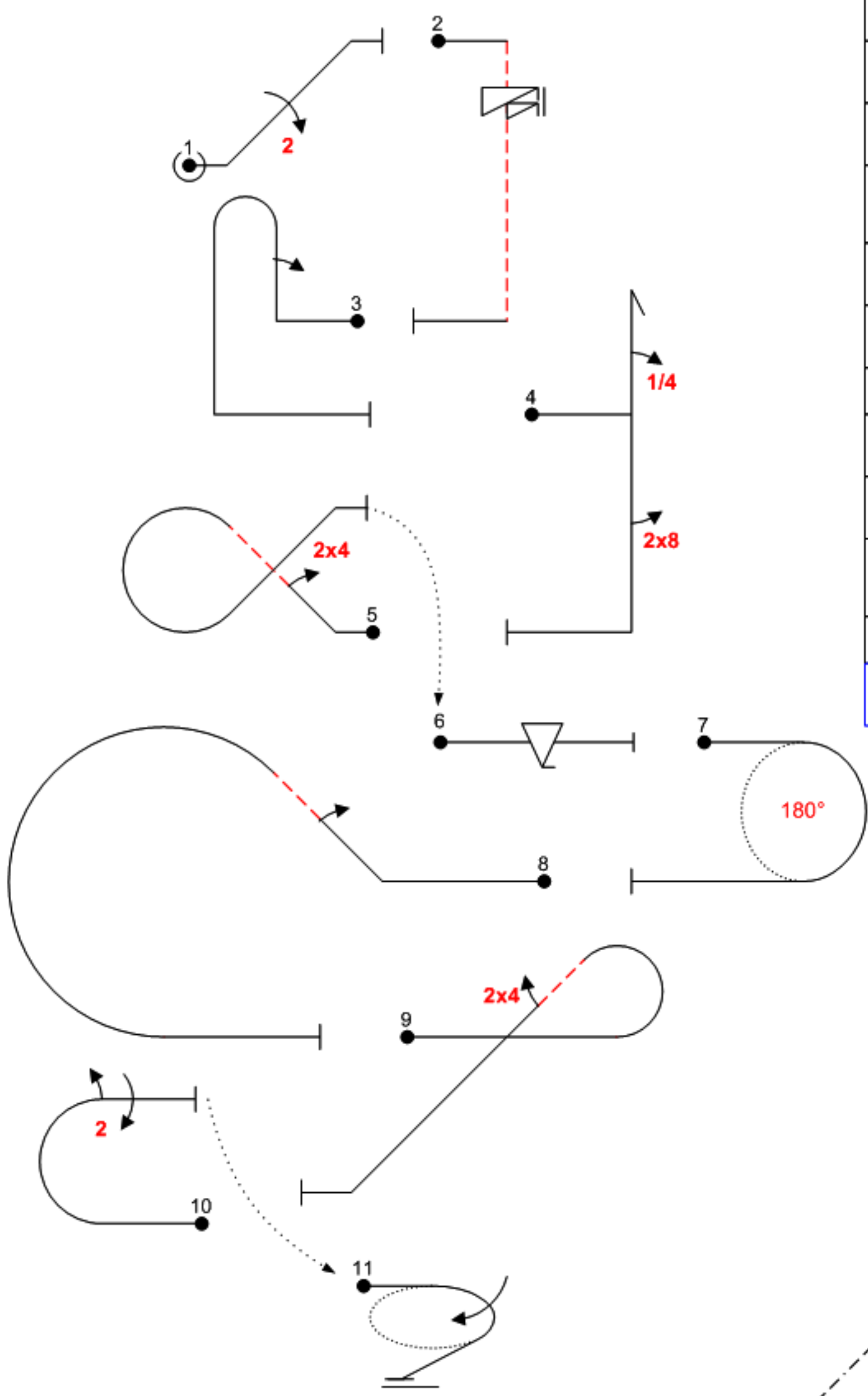
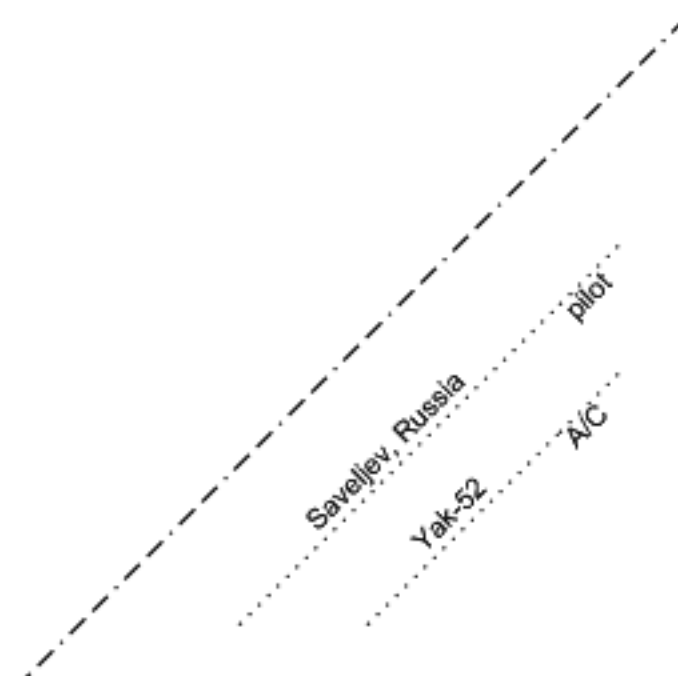

Fig 1	1.1.2.1 9.2.2.4	7 11	18
Fig 2	1.1.6.3 9.11.1.6	10 3	13
Fig 3	8.4.1.1 9.1.1.2	13 8	21
Fig 4	5.2.1.1 9.1.1.1 9.8.5.1	17 6 3	26
Fig 5	7.3.2.1 9.4.2.2	14 7	21
Fig 6	1.1.1.1 9.9.3.4	2 11	13
Fig 7	2.2.1.1	4	4
Fig 8	8.5.2.1 9.1.2.2	10 6	16
Fig 9	8.5.6.1 9.4.4.2	10 5	15
Fig 10	7.2.2.1 9.1.3.2 9.2.3.4	6 4 9	19
Fig 11	2.1.3.1	14	14

Total K = 180





3rd FAI World Aerobatic Yak-52 Championships 2012

June 23 - 30, 2012

FORM B

Pilot ID #

Yak-52 Free

Flight #

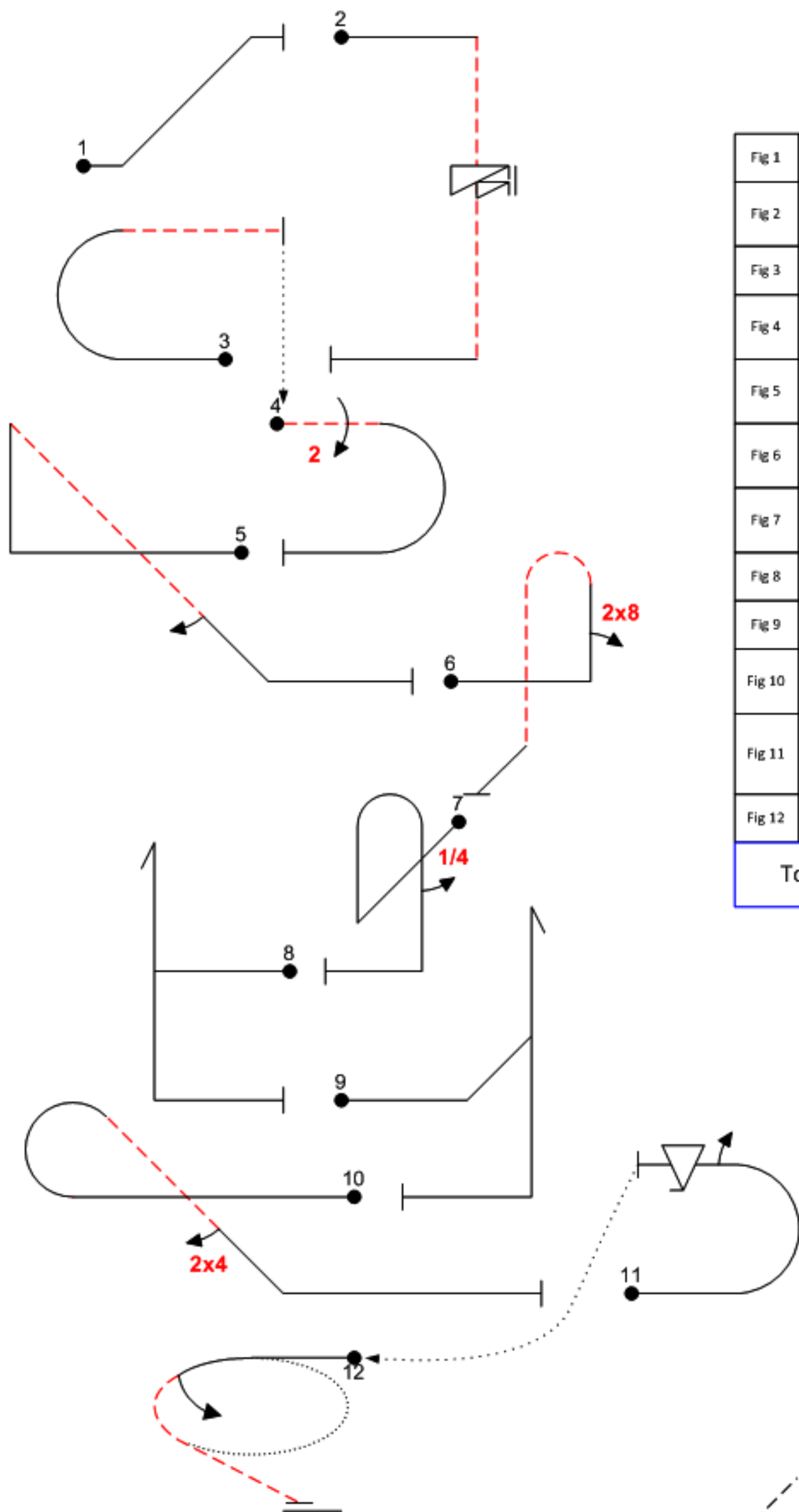
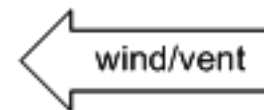

Fig 1	1.1.2.1	7	7
Fig 2	1.1.6.3 9.11.1.6	10 3	13
Fig 3	7.2.1.1	6	6
Fig 4	7.2.1.4 9.2.3.4	6 9	15
Fig 5	1.2.7.1 9.1.4.2	13 4	17
Fig 6	8.4.3.1 9.8.1.1	15 7	22
Fig 7	8.4.1.1 9.1.5.1	13 2	15
Fig 8	5.2.1.1	17	17
Fig 9	5.3.1.1	18	18
Fig 10	8.5.6.1 9.4.4.2	10 5	15
Fig 11	7.2.2.1 9.1.3.2 9.9.3.4	6 4 11	21
Fig 12	2.1.2.1	14	14

Total K = 180

Tarasevich, Krymetskiy, Ukraine pilot
Yak-52 A/C



3rd FAI World Aerobatic Yak-52 Championships 2012

June 23 - 30, 2012

FORM B

Pilot ID #	Yak-52 Free	Flight #
------------	--------------------	----------

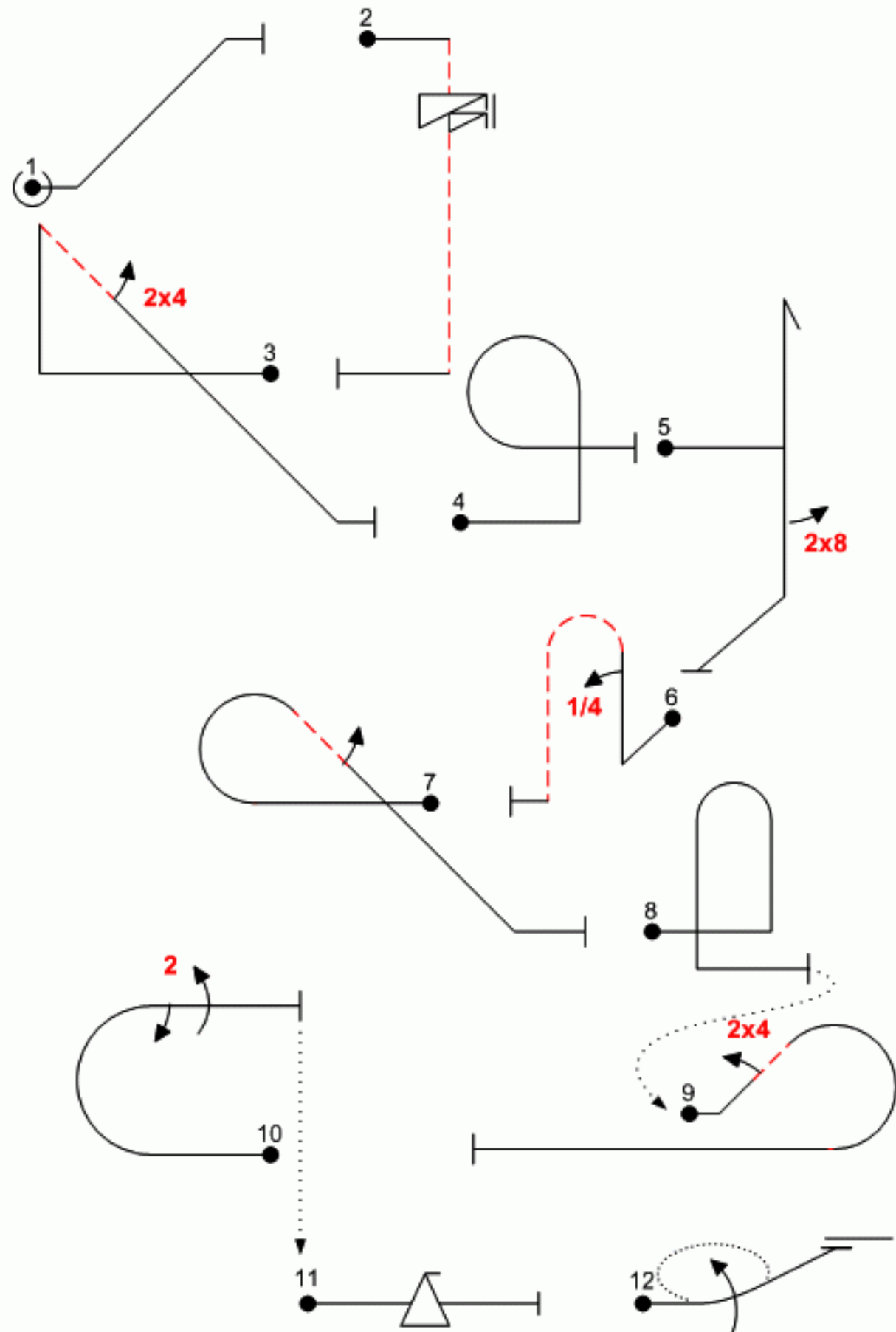

Fig 1	1.1.2.1	7	7
Fig 2	1.1.6.3 9.11.1.6	10 3	13
Fig 3	1.2.7.1 9.4.4.2	13 5	18
Fig 4	8.6.1.1	11	11
Fig 5	5.2.1.1 9.8.5.1	17 3	20
Fig 6	8.4.3.1 9.1.1.1	15 6	21
Fig 7	8.5.6.1 9.1.4.2	10 4	14
Fig 8	8.4.1.1	13	13
Fig 9	8.5.2.1 9.4.2.2	10 7	17
Fig 10	7.2.2.1 9.1.3.2 9.2.3.4	6 4 9	19
Fig 11	1.1.1.1 9.9.3.4	2 11	13
Fig 12	2.1.3.1	14	14

Total K = 180

Ferreira RSA pilot
Yak-52 A/C



Pilot ID #	Yak-52 Free	Flight #
------------	-------------	----------

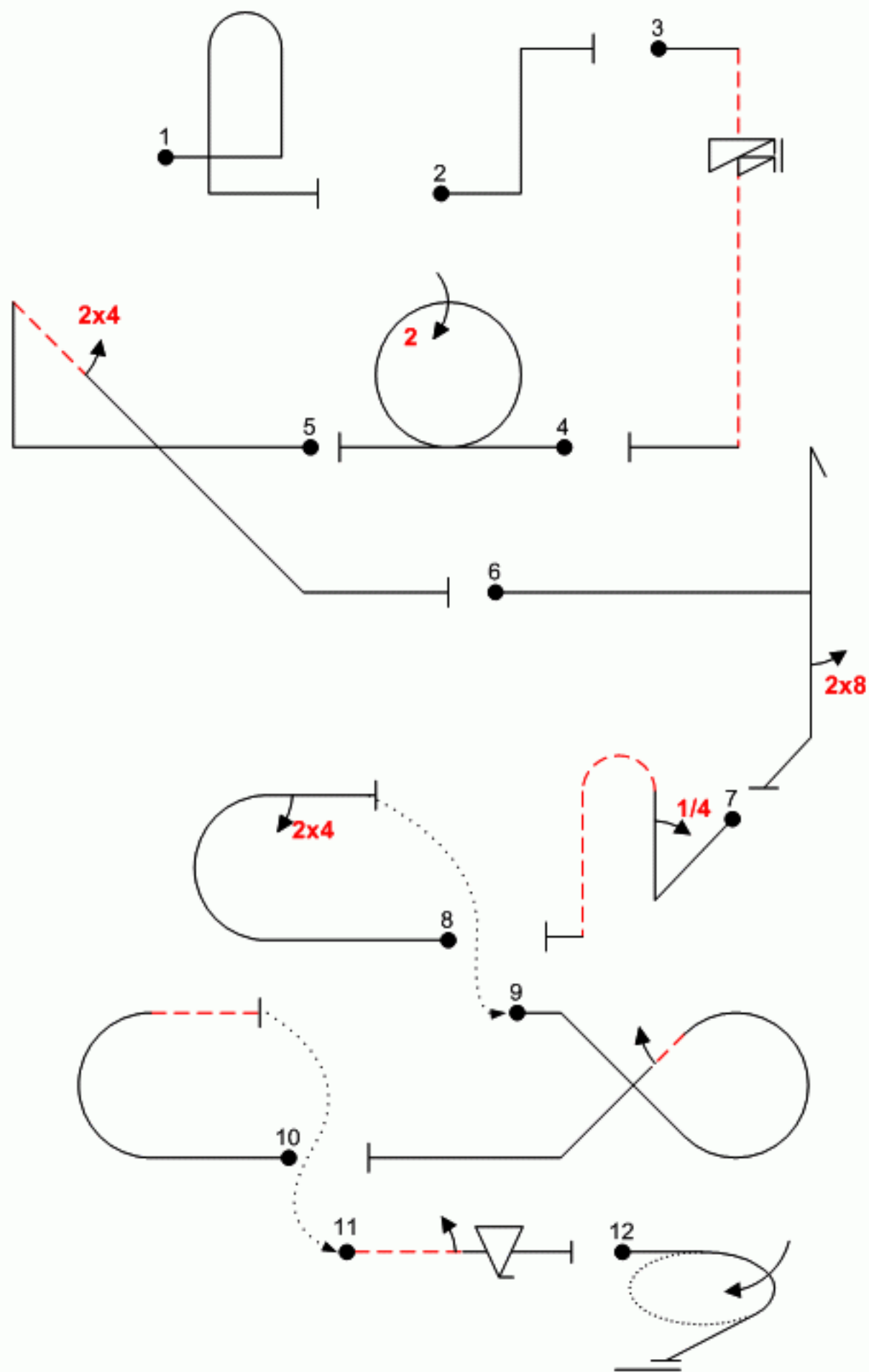

Fig 1	8.4.1.1	13	13
Fig 2	1.1.6.1	10	10
Fig 3	1.1.6.3 9.11.1.6	10 3	13
Fig 4	7.4.1.1 9.2.3.4	10 9	19
Fig 5	1.2.7.1 9.4.4.2	13 5	18
Fig 6	5.2.1.1 9.8.5.1	17 3	20
Fig 7	8.4.3.1 9.1.1.1	15 6	21
Fig 8	7.2.2.1 9.4.3.2	6 5	11
Fig 9	7.3.3.3 9.1.4.2	14 4	18
Fig 10	7.2.1.1	6	6
Fig 11	1.1.1.4 9.1.3.2 9.9.3.4	2 4 11	17
Fig 12	2.1.3.1	14	14
Total K = 180			

The sequence has been checked by Aresti software and is free from detectable errors.

Хазинтов, Россия
 Yak-52
 pilot
 A/C